

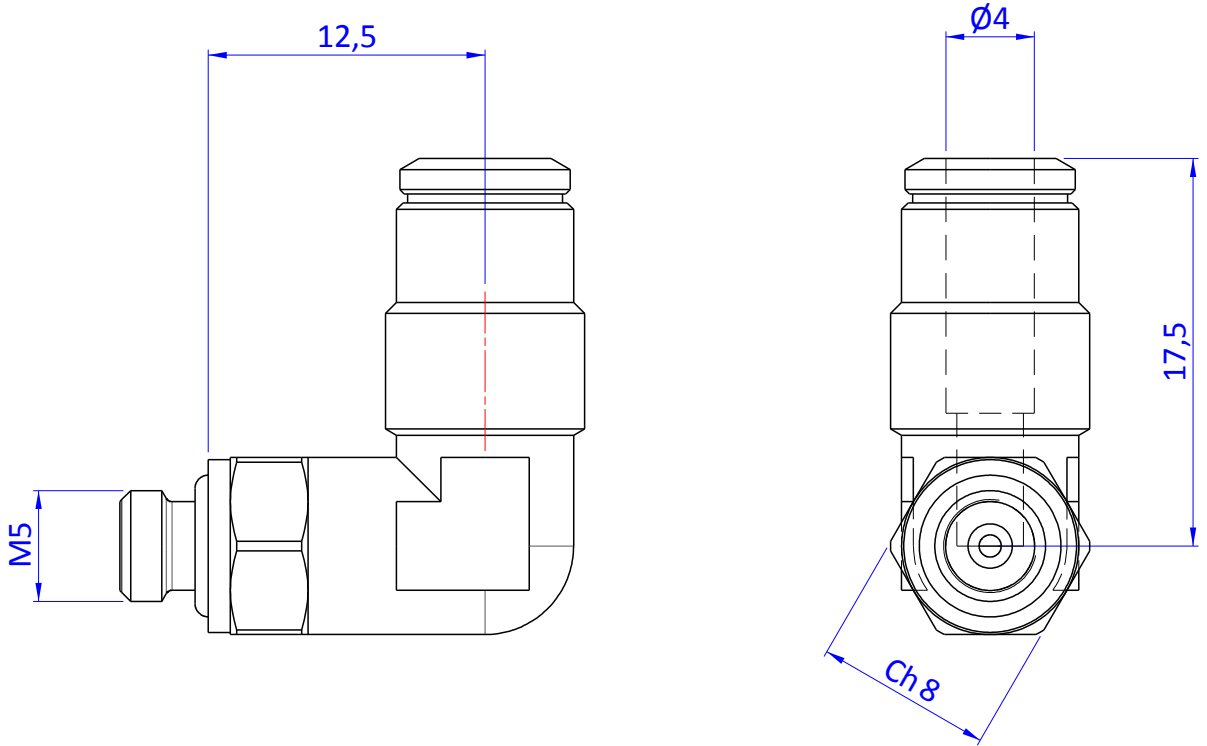

THE PROPERTY OF THE DRAWING IS ESTABLISHED BY LAW. IT IS FORBIDDEN TO PRODUCE OR SHOW IT TO THIRD PART. WITHOUT A WRITTEN AGREEMENT.

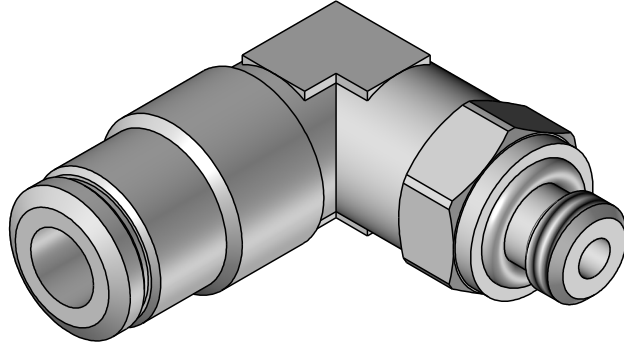
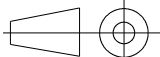

Format A4 UNI 936-76	 FPSERVICES AUTOMATION				DESIGNED FROM FPS Automation	REVIEW A
	GENERAL TOLERANCE UNI - ISO 2768 CLASSE f	DESCRIPTION CA.12.05.018			DATE 06/08/2016	WEIGHT 0.012Kg
					CODE CA.12.05.018	